



## Rettungsdatenblätter

### Modellbezeichnung

- C
- > Citigo 3-Türer
  - > Citigo 3-Türer CNG
  - > Citigo 5-Türer
  - > Citigo 5-Türer CNG
- F
- > Felicia
  - > Felicia Combi
  - > Fabia I
  - > Fabia Sedan I
  - > Fabia Combi I
  - > Fabia II
  - > Fabia Combi II
- O
- > Octavia I
  - > Octavia Combi I
  - > Octavia II
  - > Octavia Combi II
  - > Octavia II LPG
  - > Octavia Combi II LPG
  - > Octavia III
  - > Octavia Combi III
- P
- > Pick up
  - > Praktik
- R
- > Roomster
  - > Rapid NH
- S
- > Superb I
  - > Superb II
  - > Superb Combi II
- Y
- > Yeti

### Modellzyklus

- ab 2011
  - ab 2012
  - ab 2012
  - ab 2012
- 
- 1994 - 2001
  - 1995 - 2001
  - 1999 - 2007
  - 2001 - 2008
  - 2000 - 2007
  - ab 2006
  - ab 2006
- 
- ab 1996
  - ab 2000
  - ab 2004
  - ab 2004
  - ab 2009
  - ab 2009
  - ab 2012
  - ab 2013
- 
- 1995 - 2001
  - ab 2006
- 
- ab 2006
  - ab 2012
- 
- 2001 - 2008
  - ab 2008
  - ab 2009
- 
- ab 2009

**Hinweis:**

Diese Dokumentation wurde ausschließlich für Rettungskräfte erstellt, die über eine spezielle Ausbildung auf dem Gebiet der technischen Hilfeleistung nach Verkehrsunfällen und damit in Verbindung stehender Tätigkeiten verfügen.

Spezifikationen und Sonderausstattungen der Škoda-Fahrzeuge sowie das Fahrzeugangebot der **ŠKODA AUTO a.s.** unterliegen stetig etwaigen Änderungen. Daher behält sich Škoda Auto a.s. inhaltliche Anpassungen bzw. Änderungen jederzeit ausdrücklich vor.

Beachten Sie bitte, dass die in dieser Dokumentation enthaltenen Informationen nicht für Endkunden und ebenfalls nicht für Werkstätten und Händler bestimmt sind. Endkunden finden detaillierte Informationen zu den Funktionen ihres Fahrzeugs sowie wichtige Sicherheitshinweise zur Fahrzeug- und Insassensicherheit in den Bordbüchern jedes Škoda-Fahrzeugs. Werkstätten und Händler können die nötigen Reparaturinformationen über die ihnen bekannten Bezugsquellen erhalten.

(Stand: Juli 2013)

**Hinweis:**

In den Modellübersichten ist immer die maximal mögliche Ausstattung eines Fahrzeugs gezeigt.





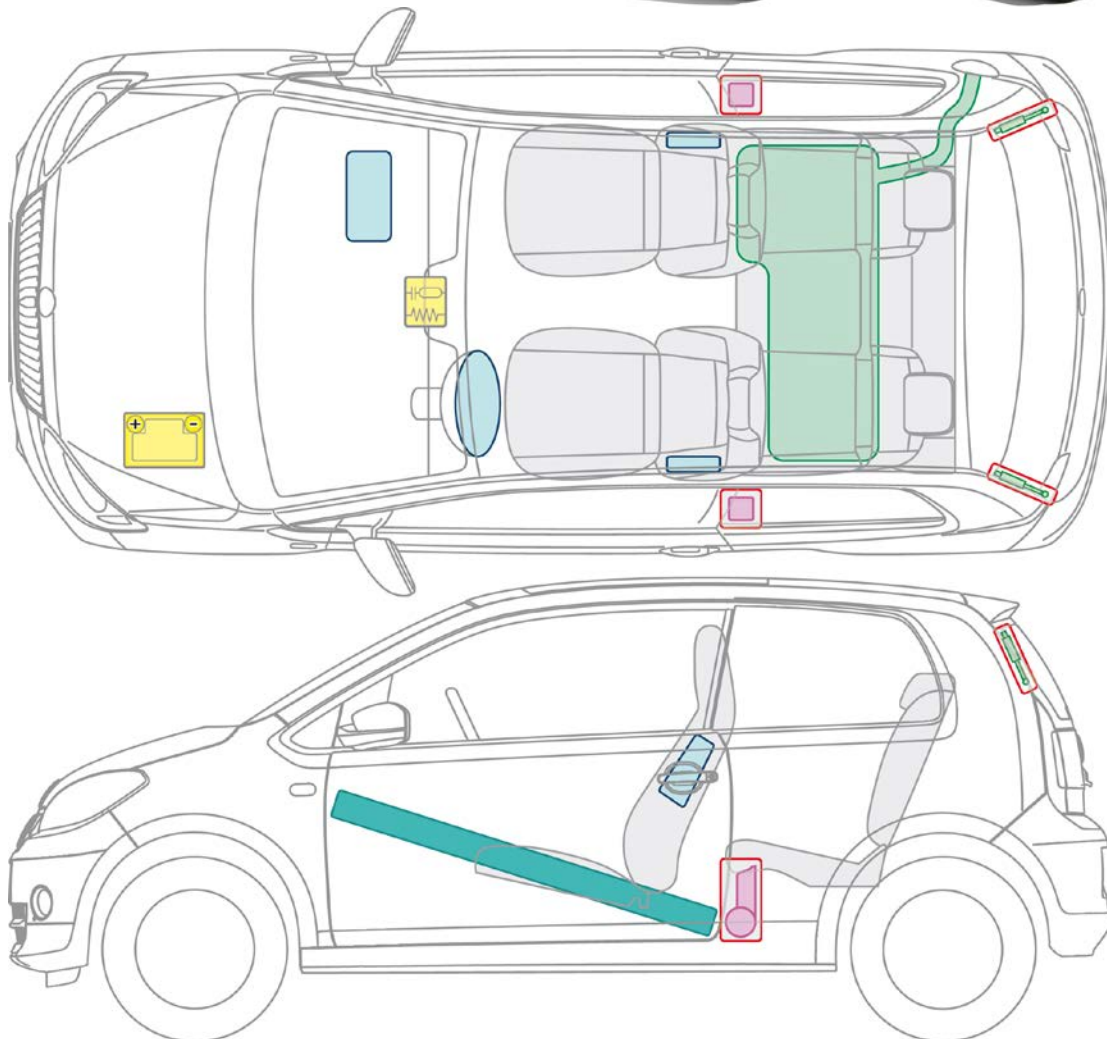

Allgemeine Informationen zur Rettung und Bergung finden Sie im Leitfaden für Rettungsdienste „Retten und Bergen aus verunfallten Fahrzeugen“ in der gleichnamigen Broschüre mit der Artikelnummer 500 5186 26 00.



## Citigo 3-Türer ab 2011

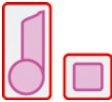

Legende

	Airbag		Karosserie- verstärkung		Steuergerät für Airbag
					Batterie
	Gurt- straffer		Gasdruck- dämpfer		Kraftstoff- tank







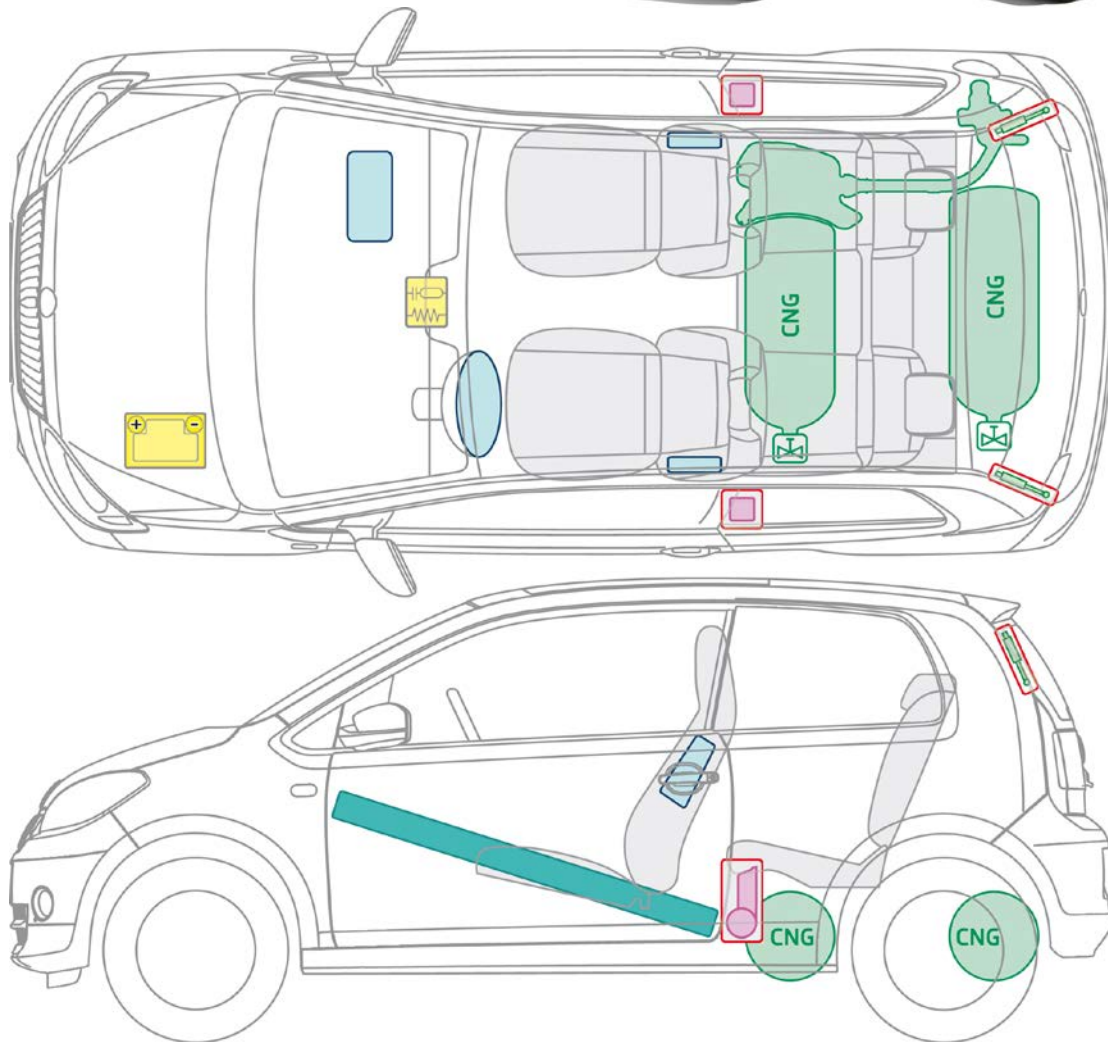

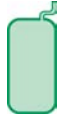

## Citigo 3-Türer CNG ab 2012

### Erdgasantrieb CITIGO

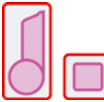

Legende





	Airbag		Karosserie- verstärkung		Kraftstoff- tank
	Batterie		Steuergerät für Airbag		Multifunktions- ventil
	Gurt- straffer		Gasdruck- dämpfer		

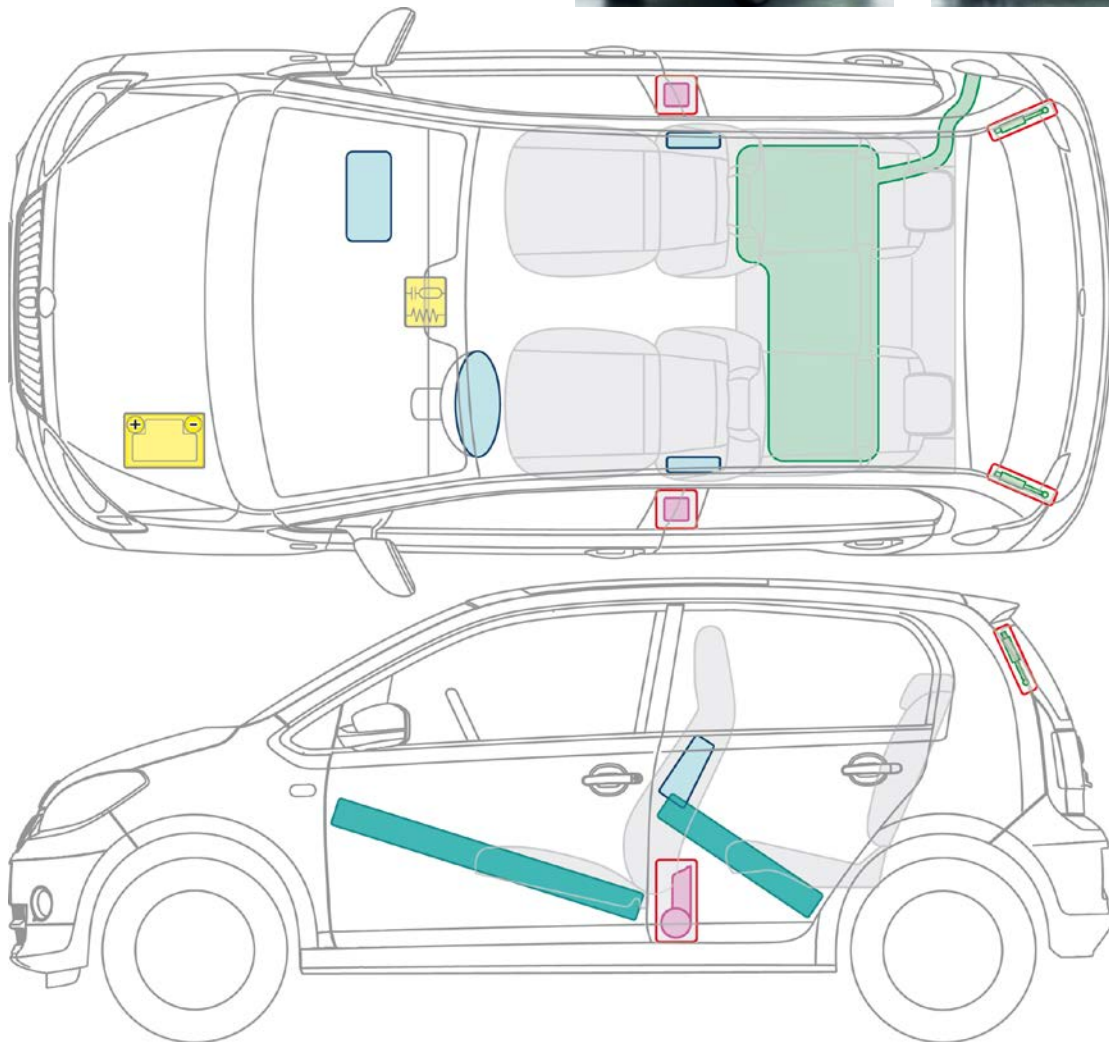

## Citigo 5-Türer ab 2012

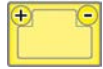

Legende

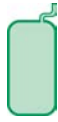
	Airbag		Karosserie- verstärkung		Steuergerät für Airbag
					Batterie
	Gurt- straffer		Gasdruck- dämpfer		Kraftstoff- tank







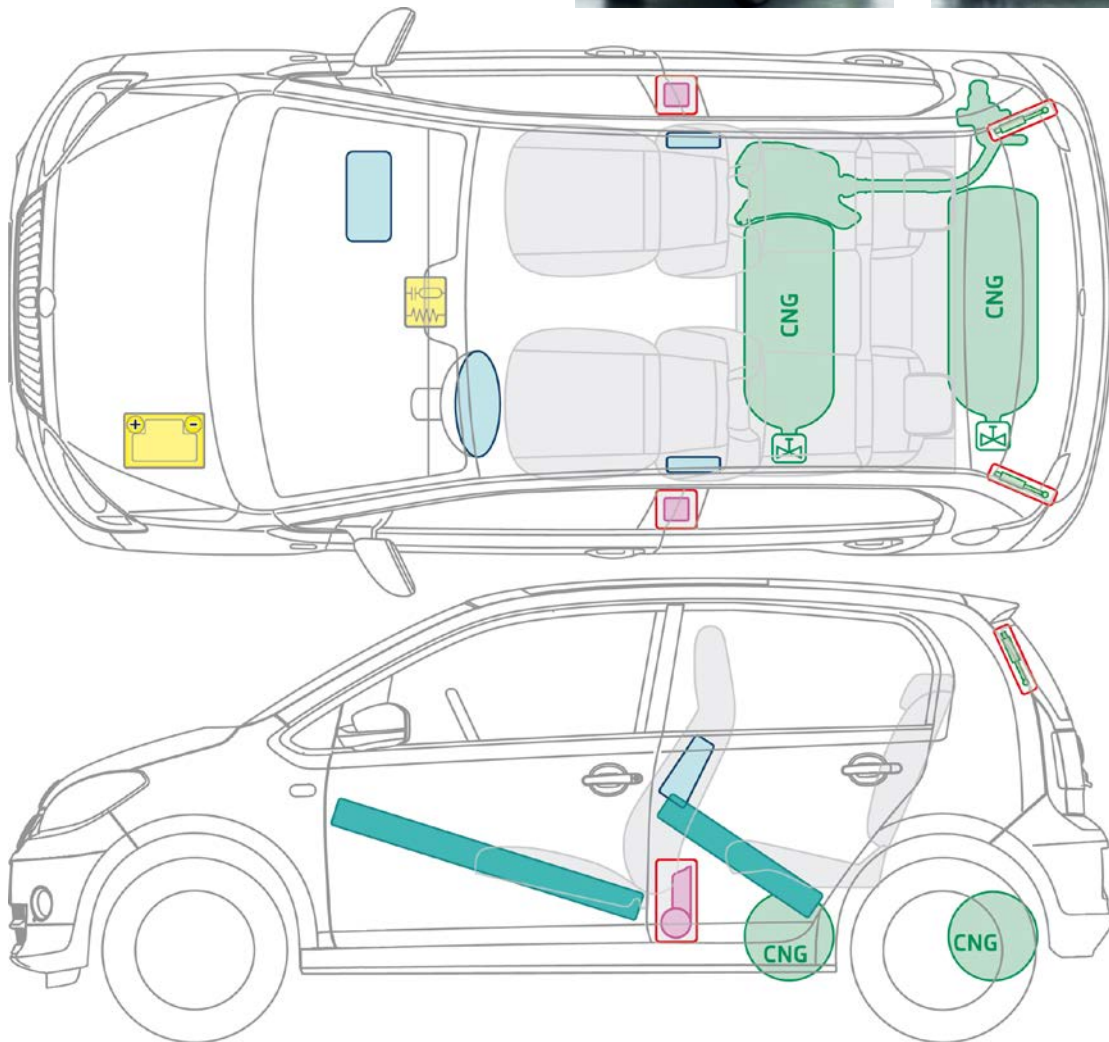

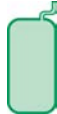

## Citigo 5-Türer CNG ab 2012

### Erdgasantrieb CITIGO

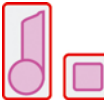

Legende





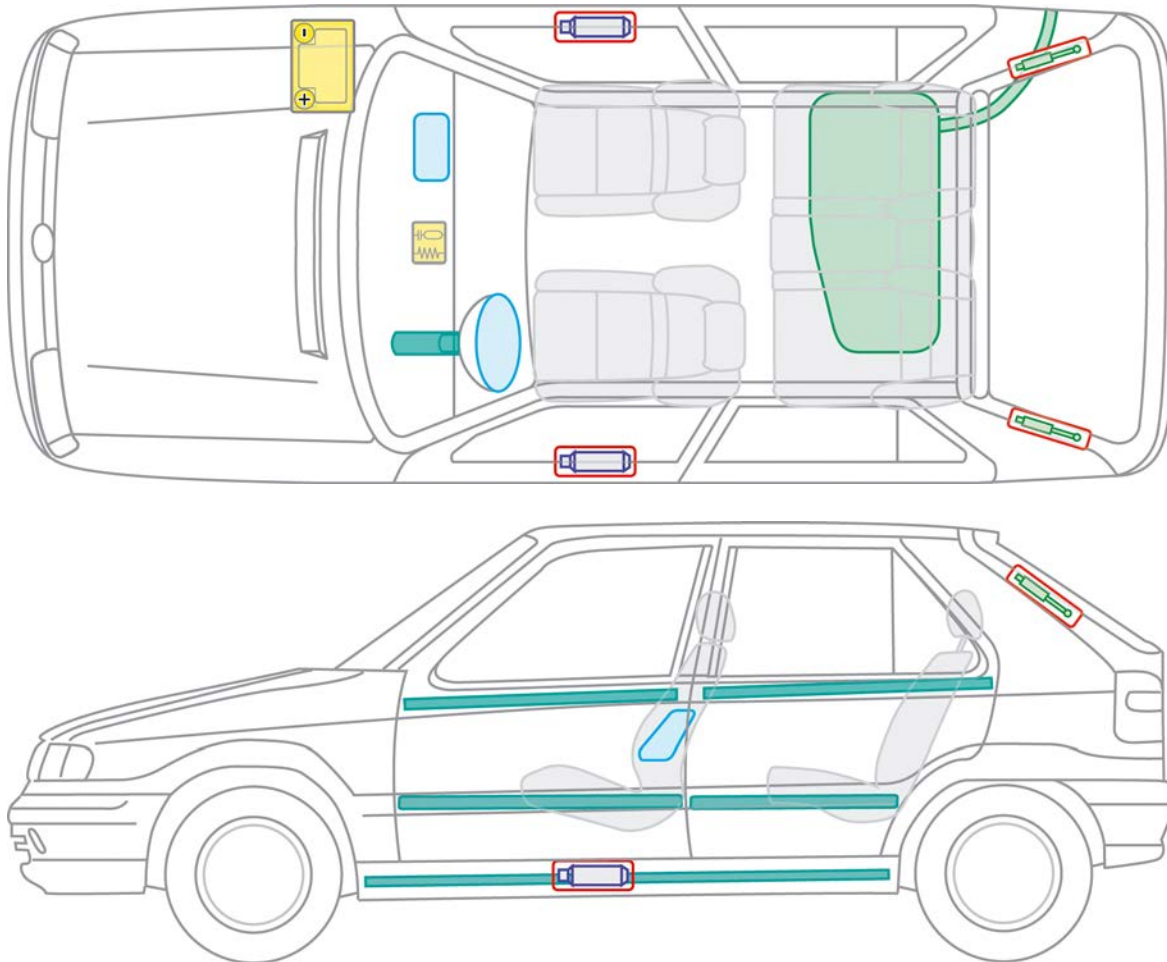

	Airbag		Karosserie- verstärkung		Kraftstoff- tank
	Batterie		Steuergerät für Airbag		Multifunktions- ventil
	Gurt- straffer		Gasdruck- dämpfer		



## Felicia 1994 - 2001

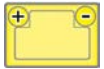

### Legende





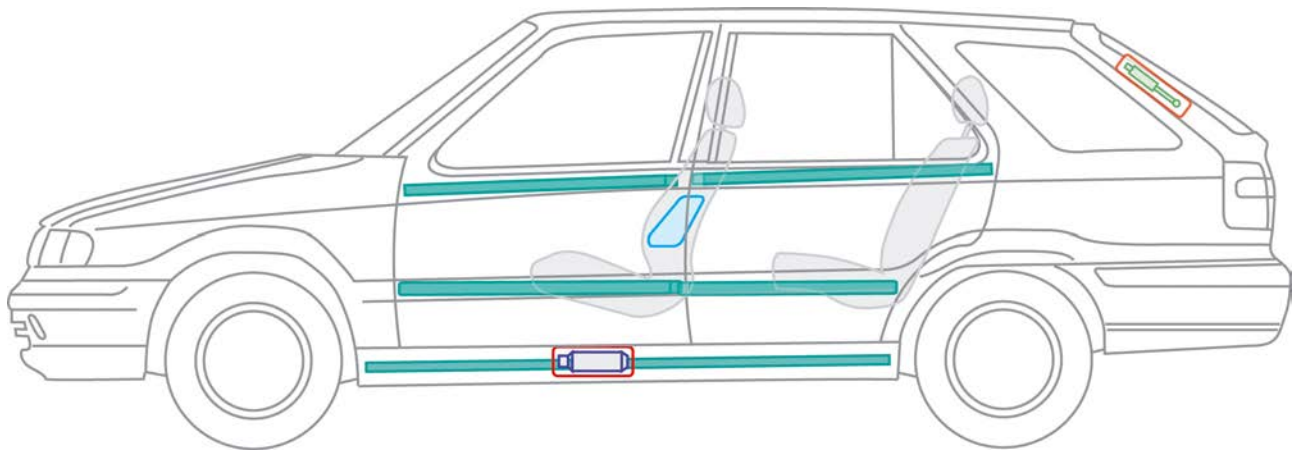
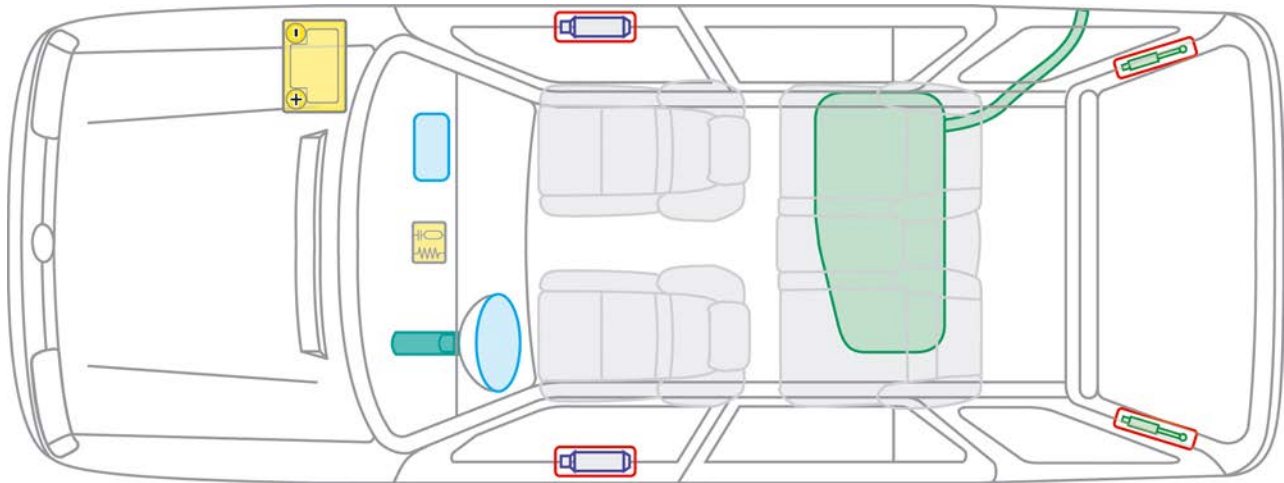

	Airbag		Karosserie- verstärkung		Steuergerät für Airbag
	Gas- generator		Batterie		Gasdruck- dämpfer
	Kraftstoff- tank				



## Felicia Combi 1995 - 2001



### Legende

	Airbag		Karosserie- verstärkung		Steuergerät für Airbag
	Gas- generator		Batterie		Gasdruck- dämpfer
	Kraftstoff- tank				







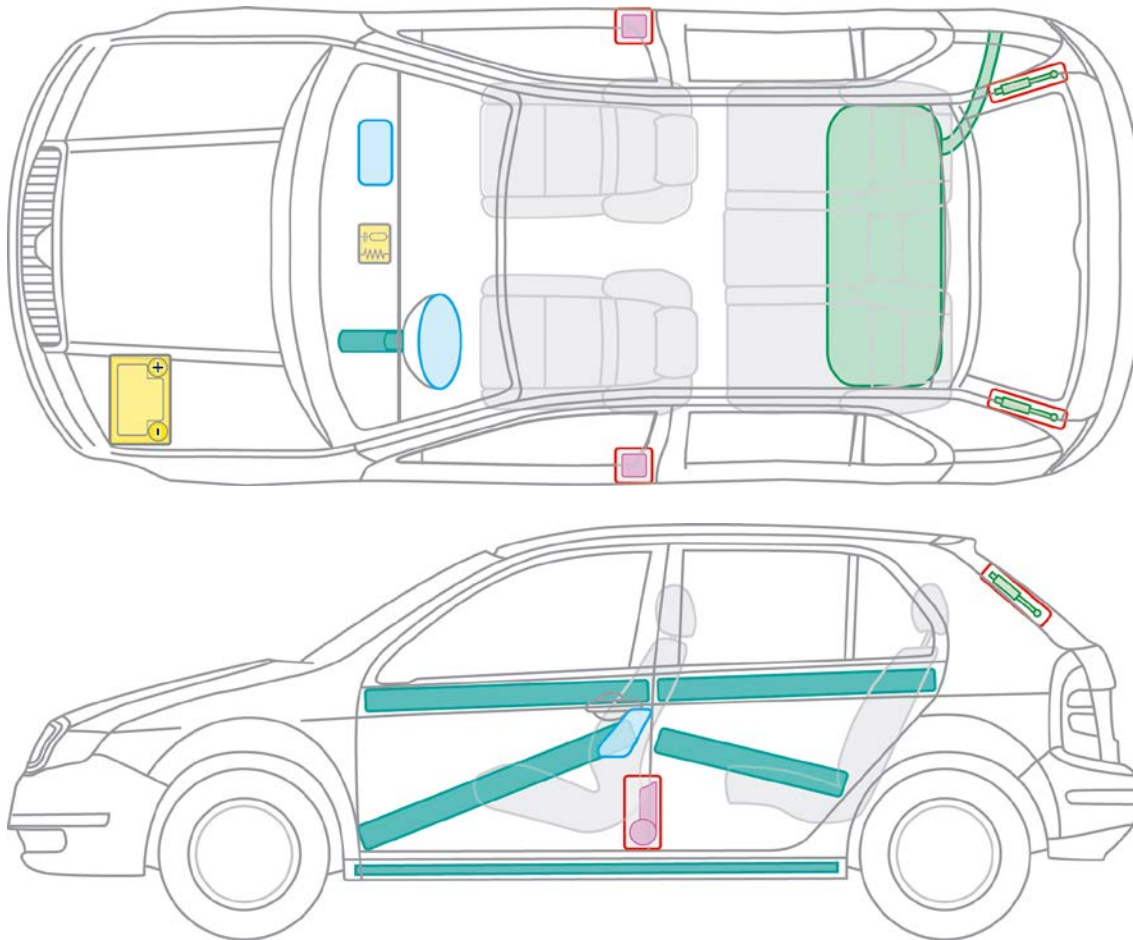



## Fabia I 1999 - 2007

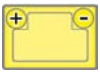

### Legende





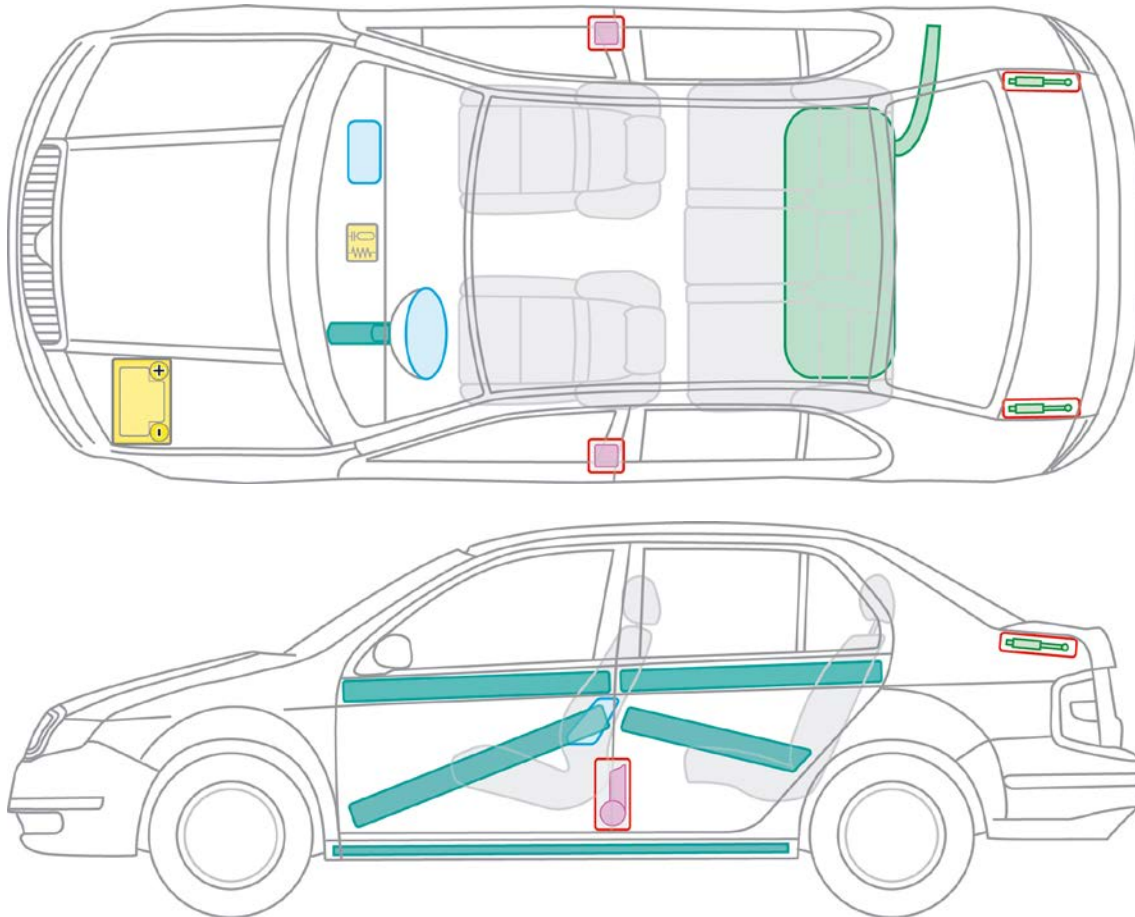

 <p>Airbag</p>	 <p>Karosserie- verstärkung</p>	 <p>Steuergerät für Airbag</p>
 <p>Batterie</p>	  <p>Gurt- straffer</p>	 <p>Gasdruck- dämpfer</p>
 <p>Kraftstoff- tank</p>		



## Fabia Sedan I 2001 - 2008



### Legende





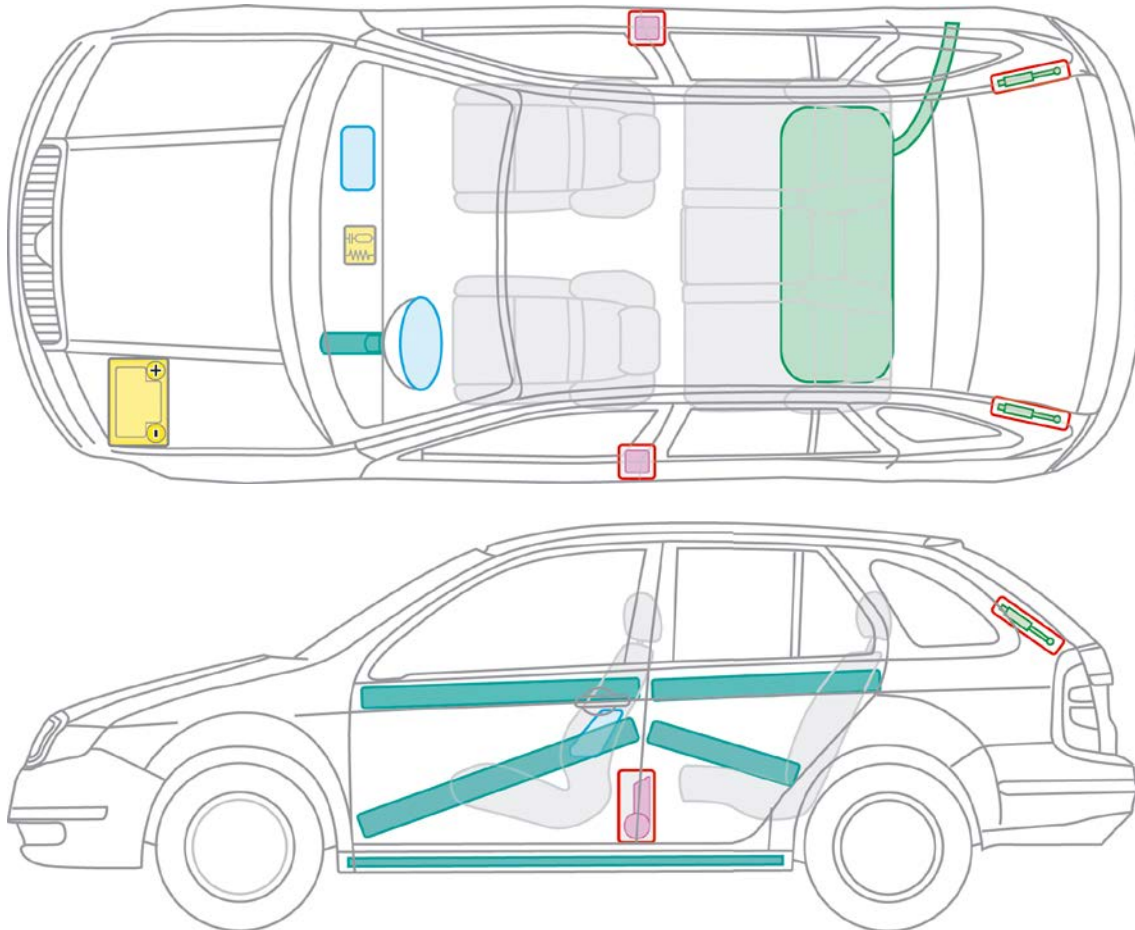

 <p>Airbag</p>	 <p>Karosserie- verstärkung</p>	 <p>Steuergerät für Airbag</p>
 <p>Batterie</p>	 <p>Gurt- straffer</p>	 <p>Gasdruck- dämpfer</p>
 <p>Kraftstoff- tank</p>		



## Fabia Combi I 2000 - 2007

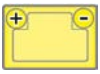

### Legende







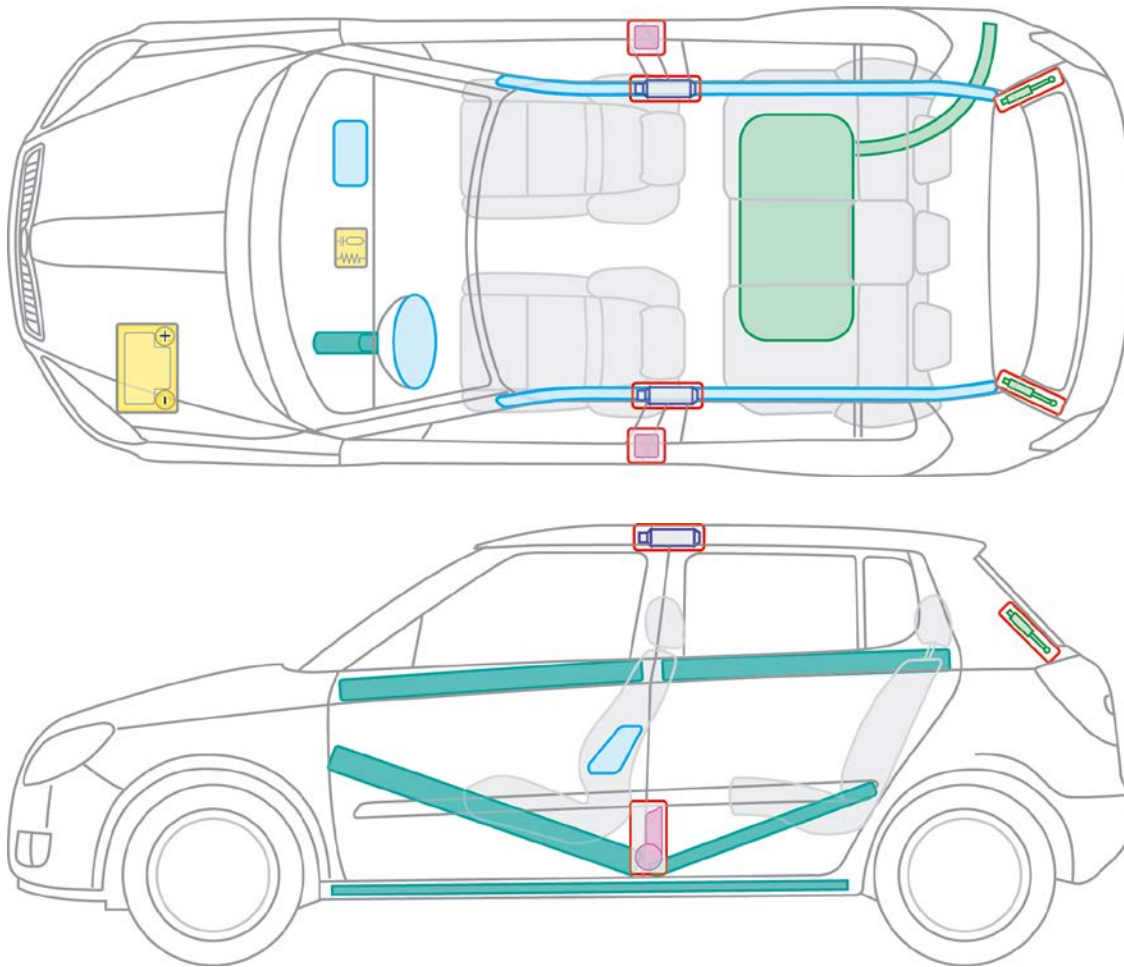

 <p>Airbag</p>	 <p>Karosserie- verstärkung</p>	 <p>Steuergerät für Airbag</p>
 <p>Batterie</p>	 <p>Gurt- straffer</p>	 <p>Gasdruck- dämpfer</p>
 <p>Kraftstoff- tank</p>		



# Fabia II ab 2006

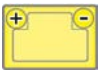

Legende





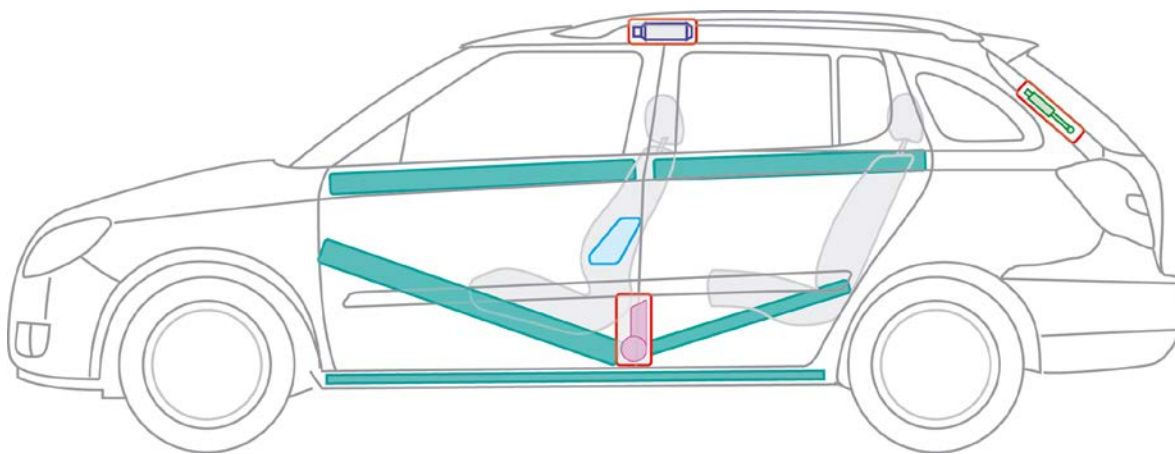
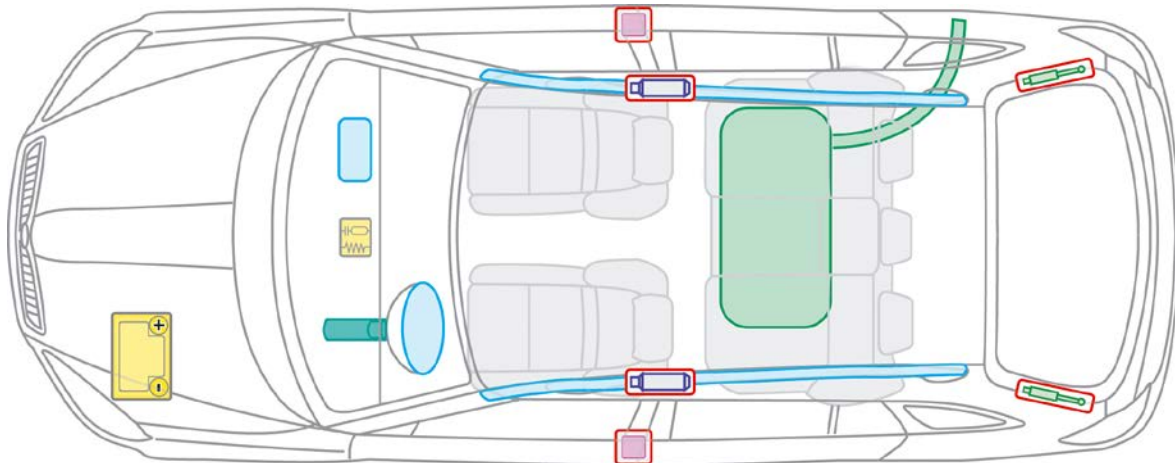

	Airbag		Karosserie- verstärkung		Steuergerät für Airbag
	Gas- generator		Batterie		Gurt- straffer
	Gasdruck- dämpfer		Kraftstoff- tank		



## Fabia Combi II ab 2006

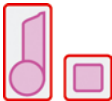

### Legende





	Airbag		Karosserie- verstärkung		Steuergerät für Airbag
	Gas- generator		Batterie		Gurt- straffer
	Gasdruck- dämpfer		Kraftstoff- tank		

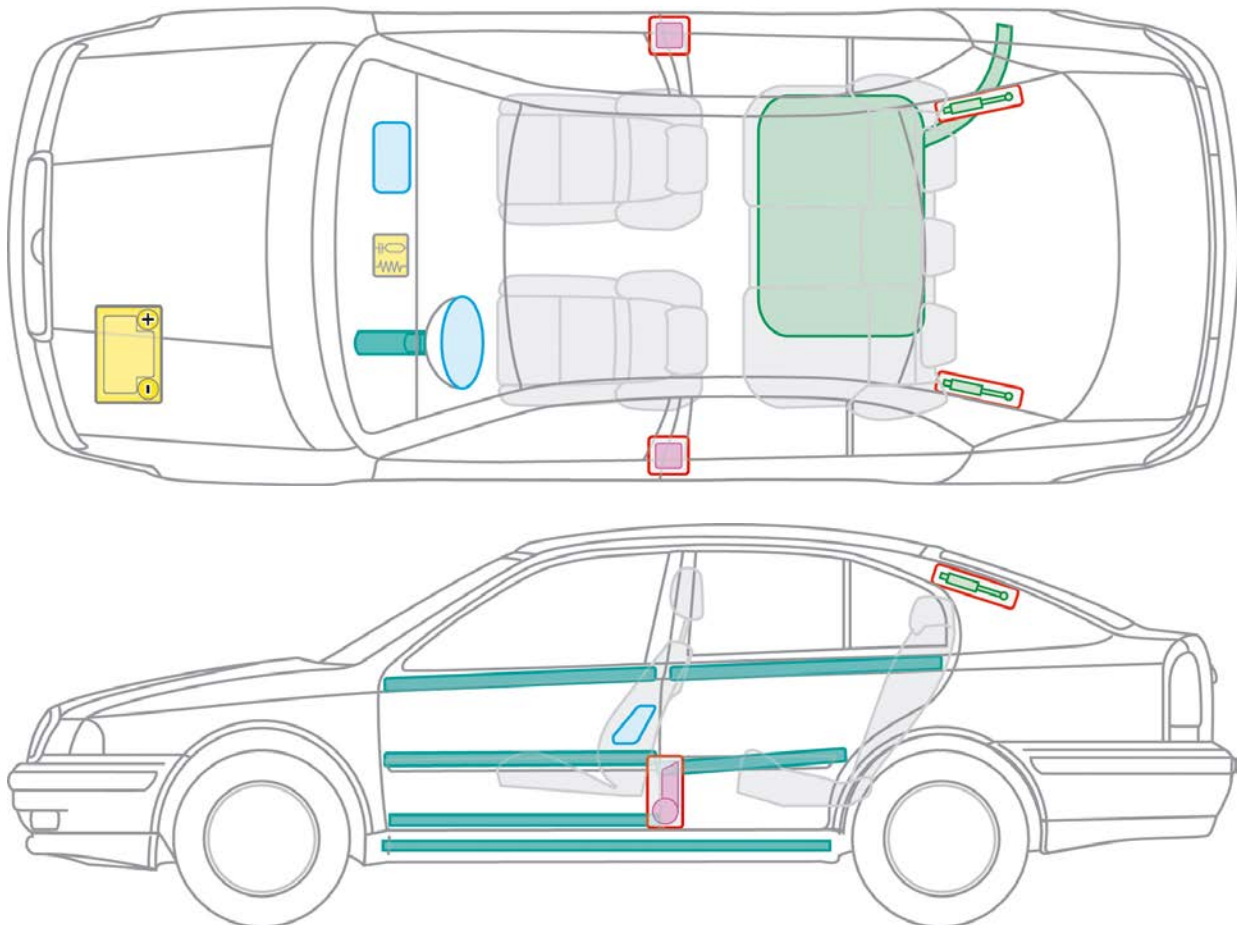

## Octavia I ab 1996

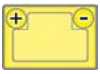
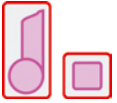

### Legende





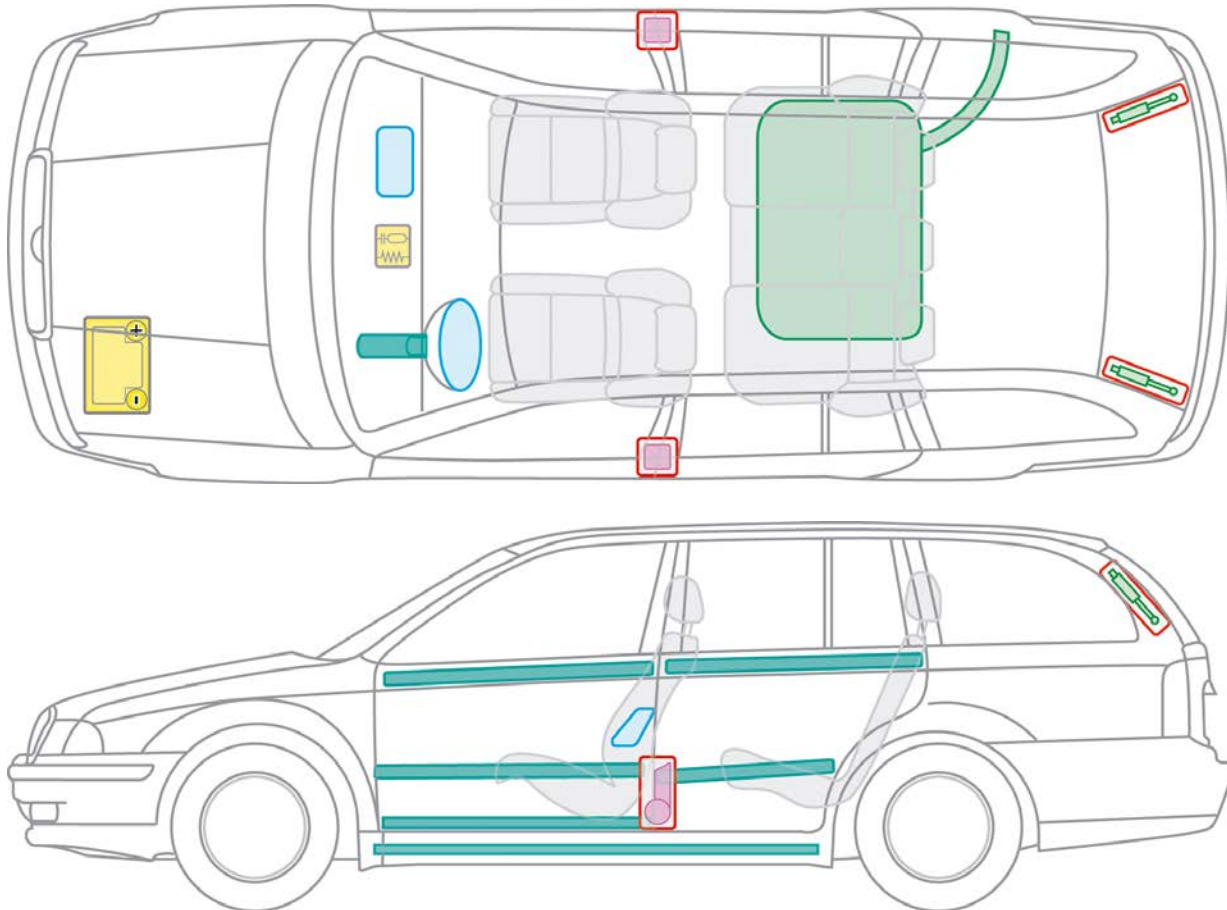

	Airbag		Karosserie- verstärkung		Steuergerät für Airbag
	Batterie		Gurt- straffer		Gasdruck- dämpfer
	Kraftstoff- tank				



## Octavia Combi I ab 2000



### Legende







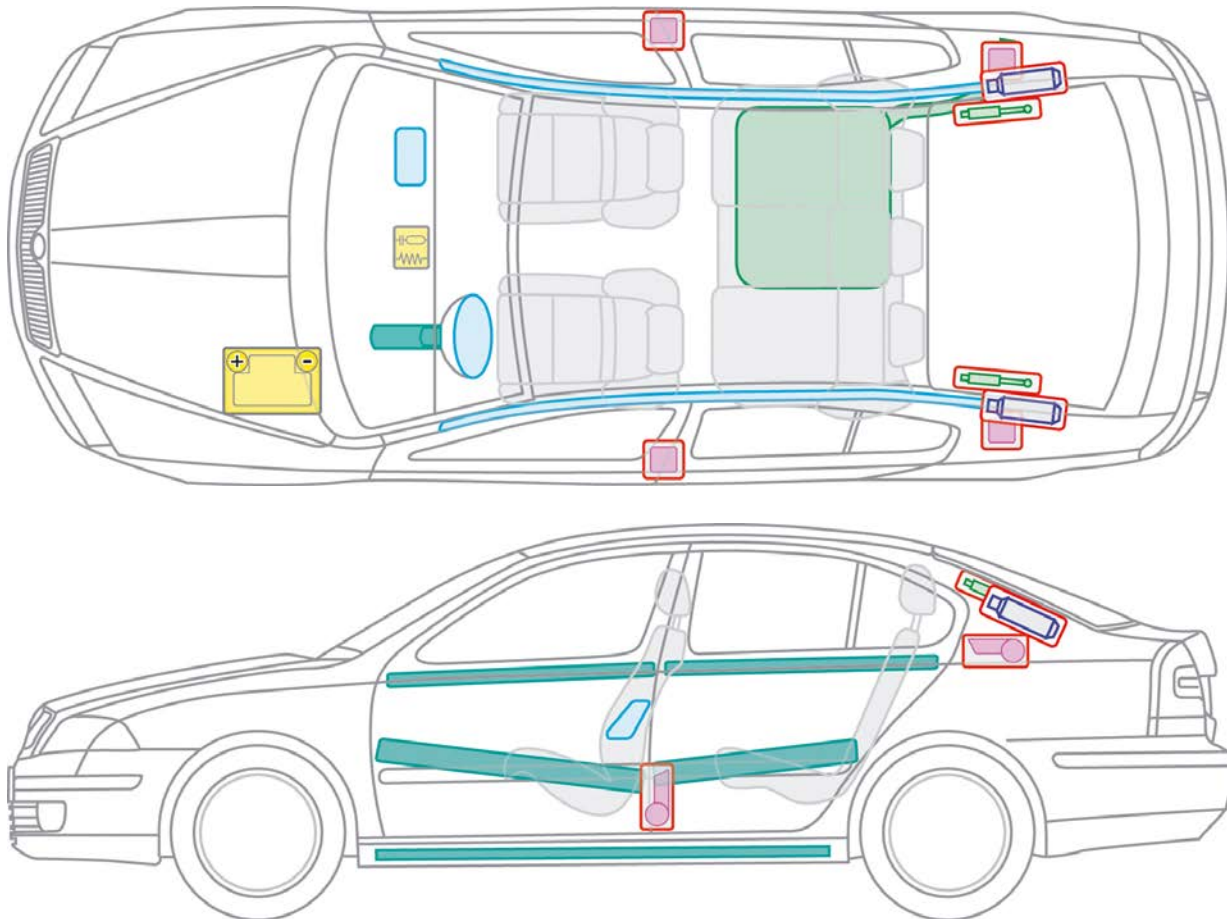

	Airbag		Karosserie- verstärkung		Steuergerät für Airbag
	Batterie		Gurt- straffer		Gasdruck- dämpfer
	Kraftstoff- tank				



## Octavia II ab 2004



### Legende

	Airbag		Karosserie- verstärkung		Steuergerät für Airbag
	Gas- generator		Batterie		Gurt- straffer
	Gasdruck- dämpfer		Kraftstoff- tank		







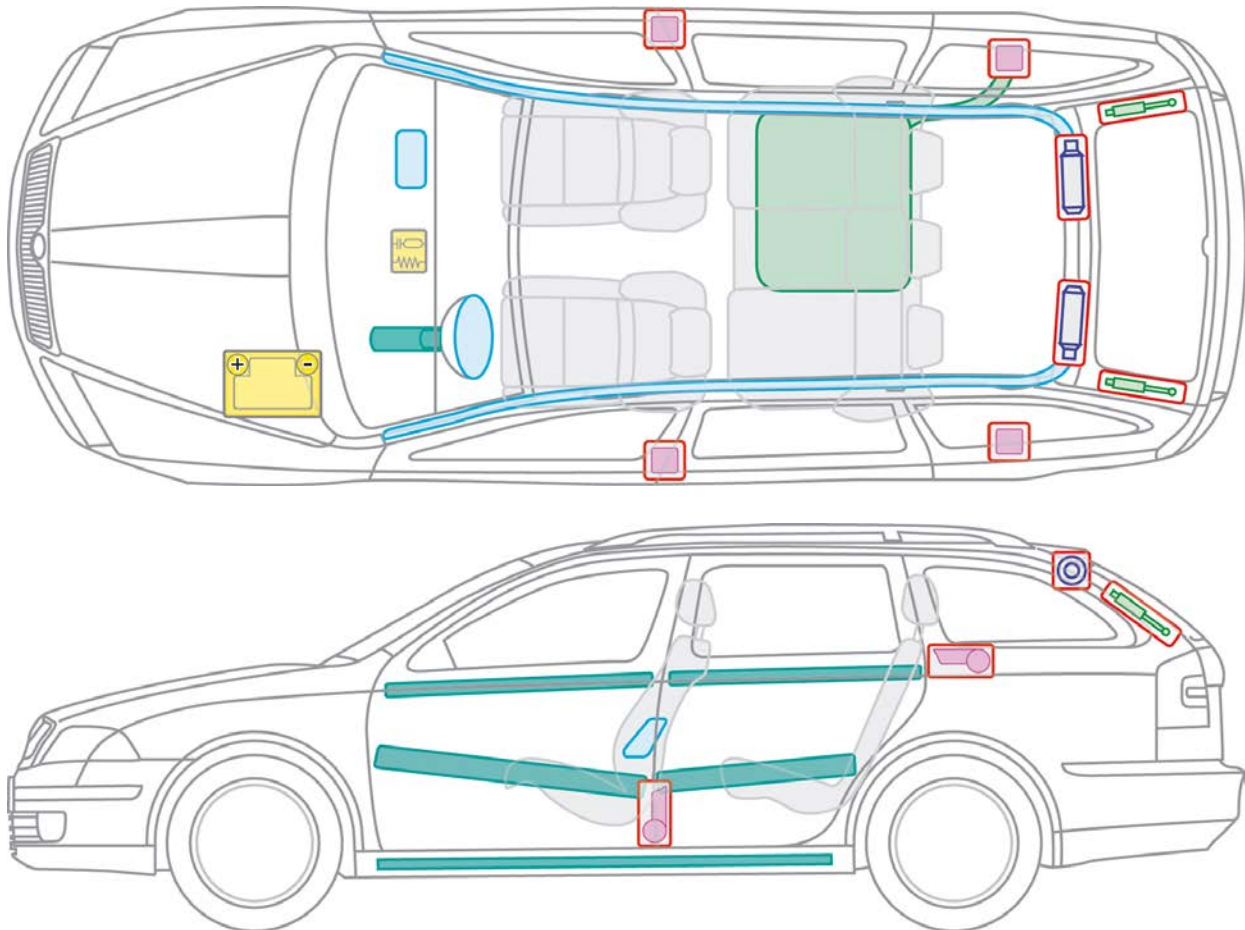

## Octavia Combi II ab 2004

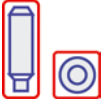
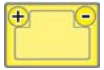
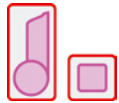

### Legende

	Airbag		Karosserie- verstärkung		Steuergerät für Airbag
	Gas- generator		Batterie		Gurt- straffer
	Gasdruck- dämpfer		Kraftstoff- tank		









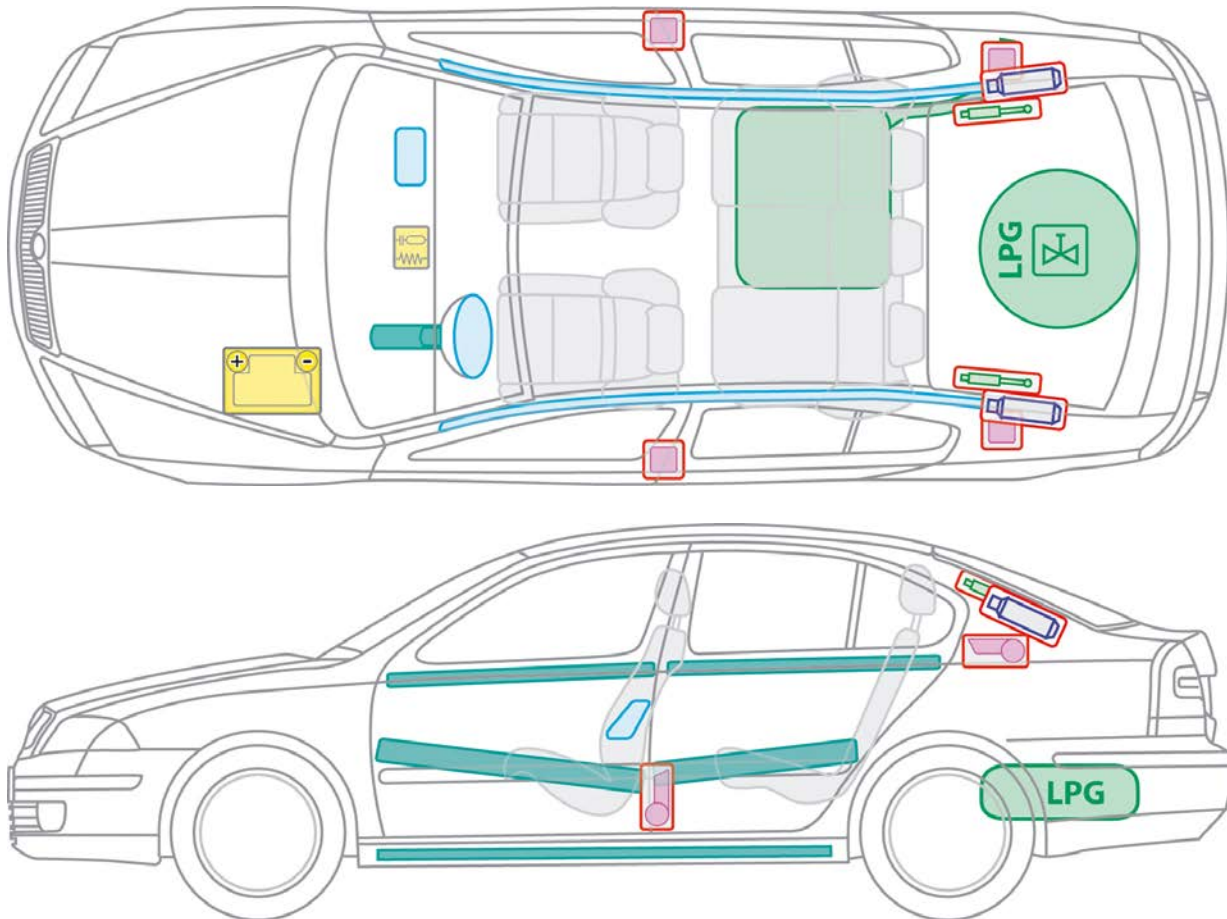

## Octavia II LPG ab 2009

### Flüssiggasantrieb

# MPI

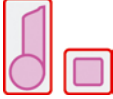

#### Legende

	Airbag		Karosserie- verstärkung		Steuergerät für Airbag
	Gas- generator		Batterie		Gurt- straffer
	Gasdruck- dämpfer		Kraftstoff- tank		Multifunktions- ventil









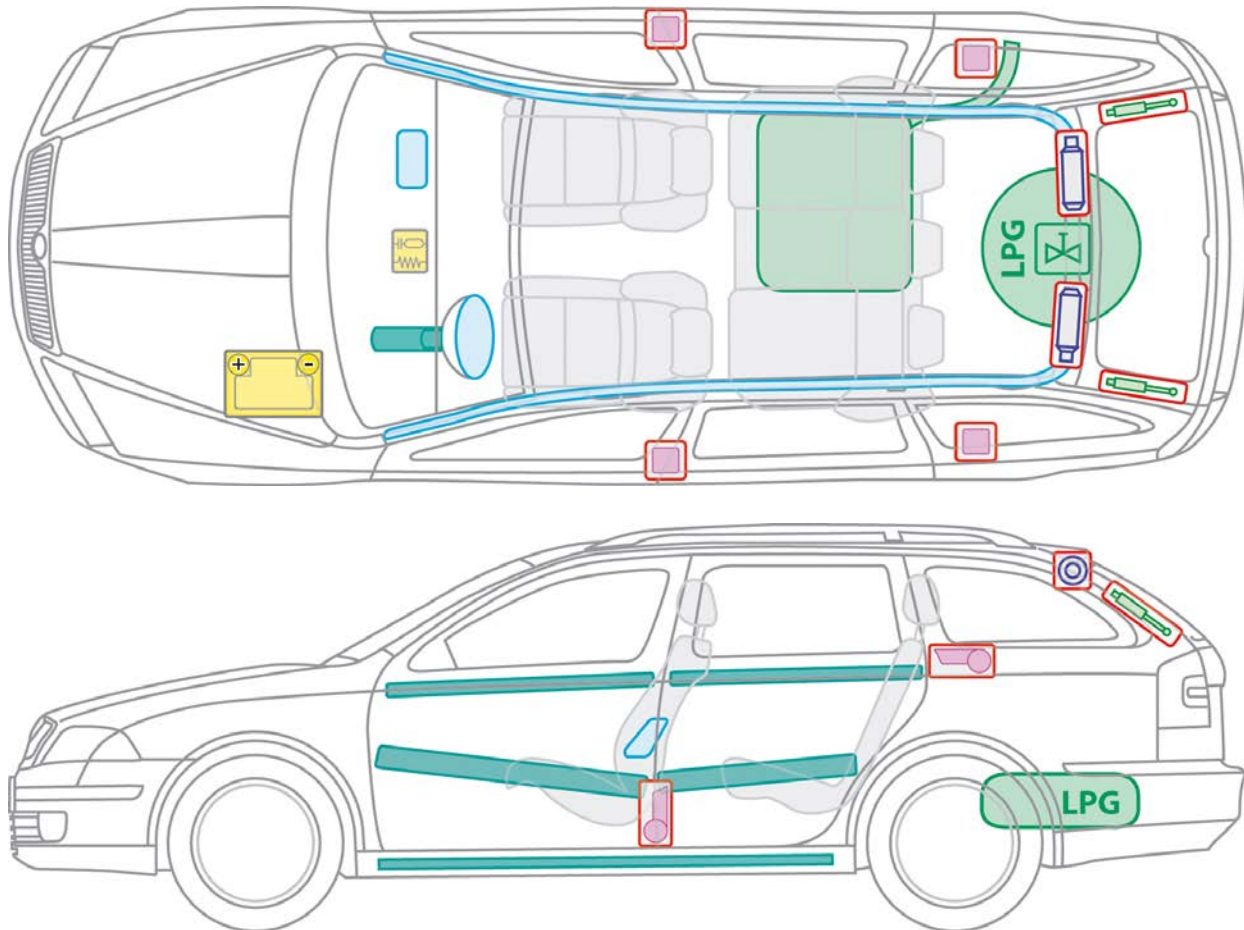

## Octavia Combi II LPG ab 2009

### Flüssiggasantrieb

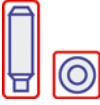
**MPI**

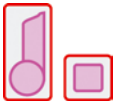

#### Legende







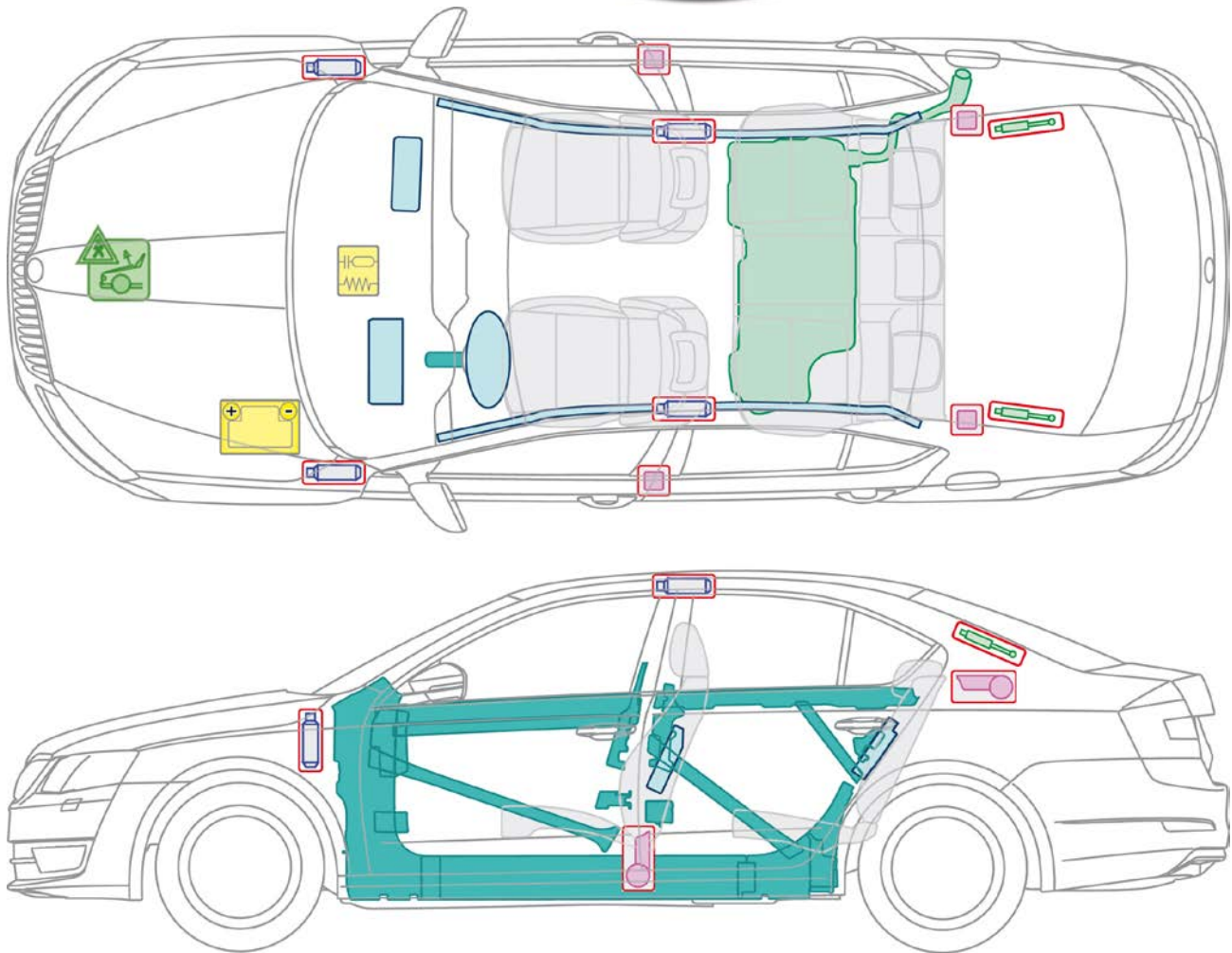

	Airbag		Karosserie- verstärkung		Steuergerät für Airbag
	Gas- generator		Batterie		Gurt- straffer
	Gasdruck- dämpfer		Kraftstoff- tank		Multifunktions- ventil



## Octavia III ab 2012

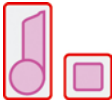

### Legende







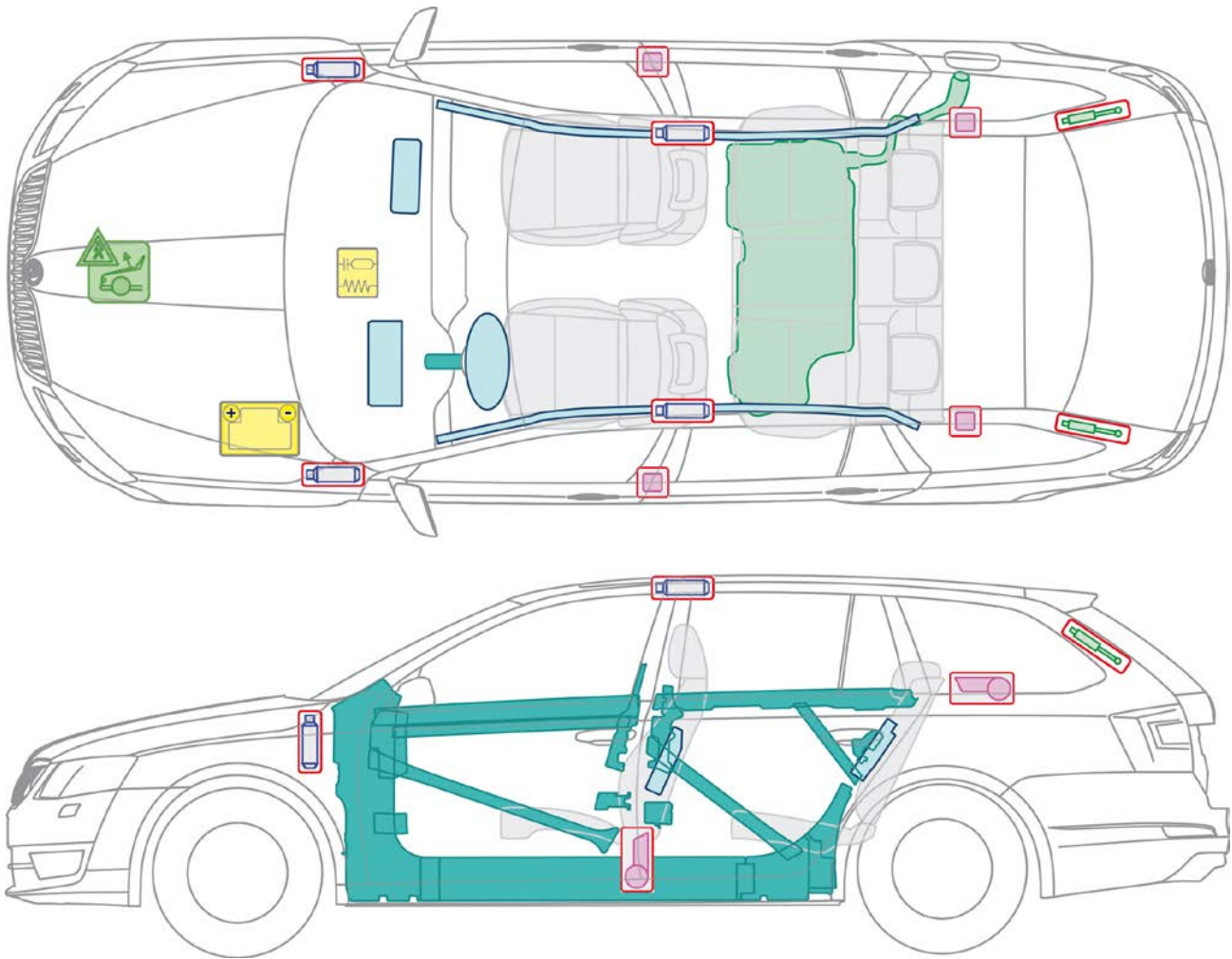

	Airbag		Karosserie- verstärkung		Steuergerät für Airbag
	Gas- generator		Batterie		Gurt- straffer
	Gasdruck- dämpfer		Kraftstoff- tank		Fußgängerschutz- system Bis KW 21/2013



## Octavia Combi III ab 2013

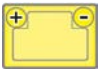
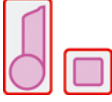

### Legende





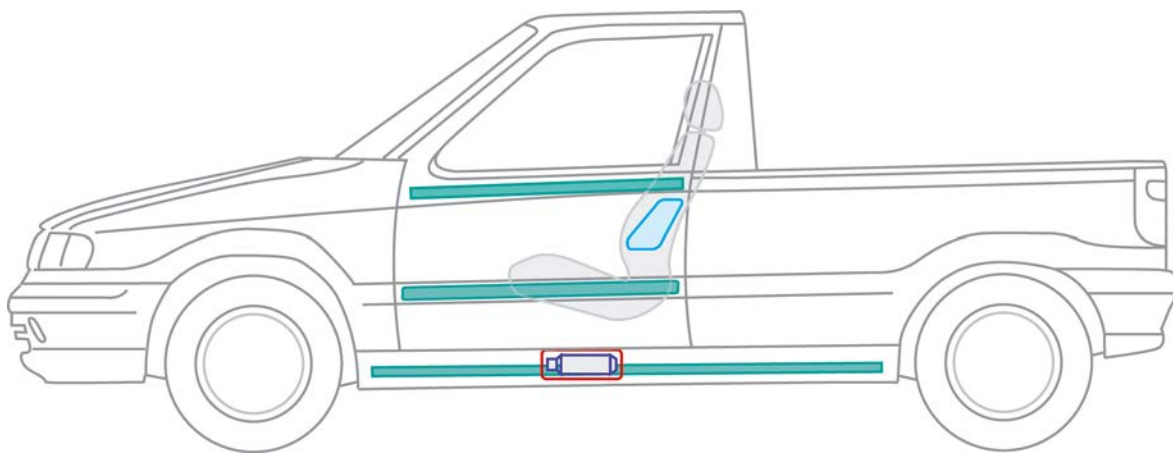
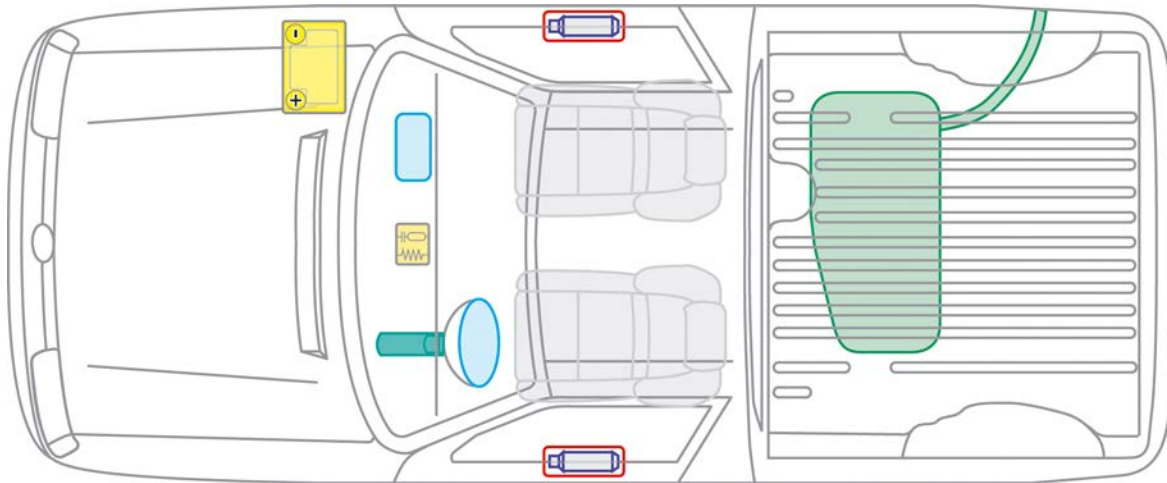

	Airbag		Karosserie- verstärkung		Steuergerät für Airbag
	Gas- generator		Batterie		Gurt- straffer
	Gasdruck- dämpfer		Kraftstoff- tank		Fußgängerschutz- system Bis KW 21/2013



## Pick up 1995 - 2001

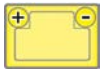

### Legende





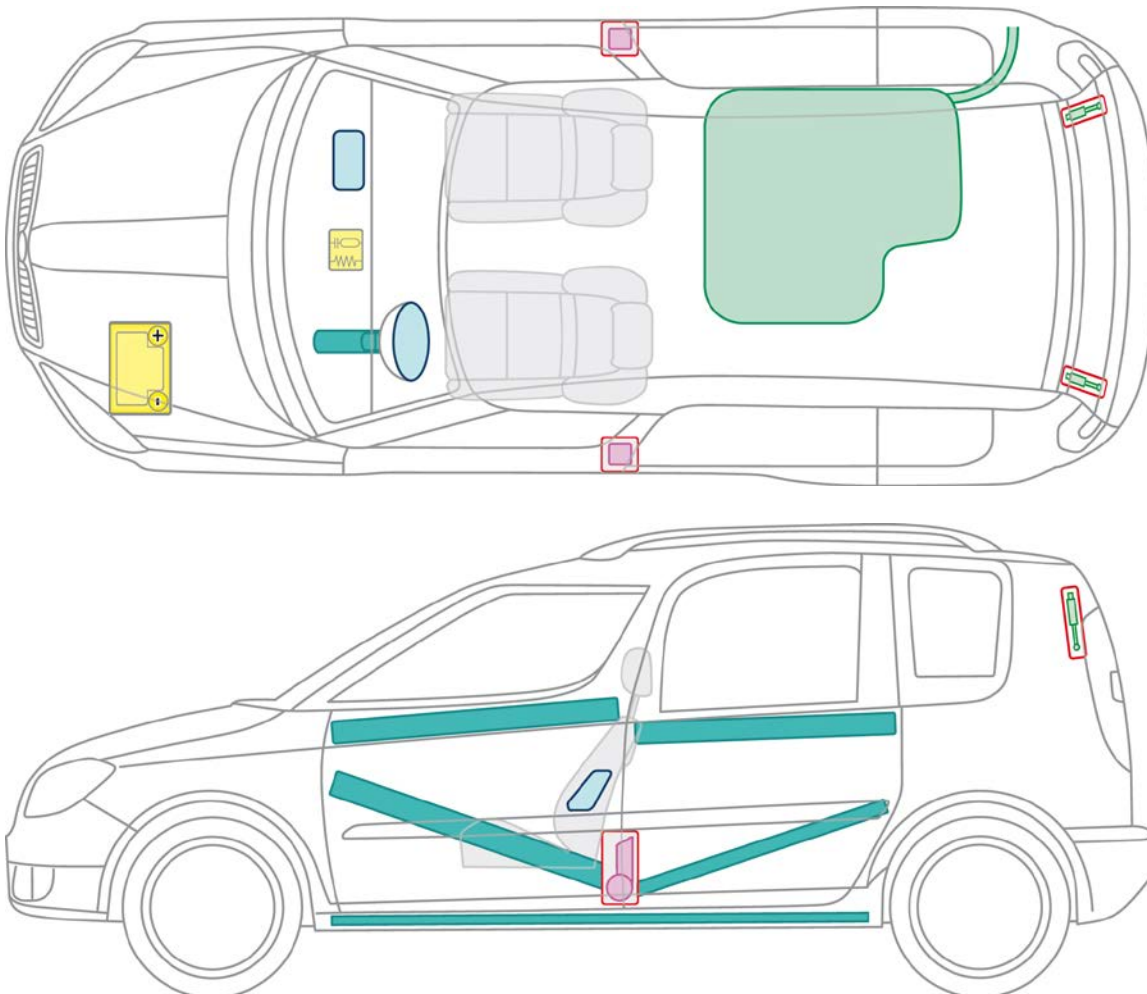

	Airbag		Karosserie- verstärkung		Steuergerät für Airbag
	Gas- generator		Batterie		Gasdruck- dämpfer
	Kraftstoff- tank				



## Praktik ab 2006



Legende

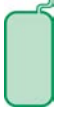





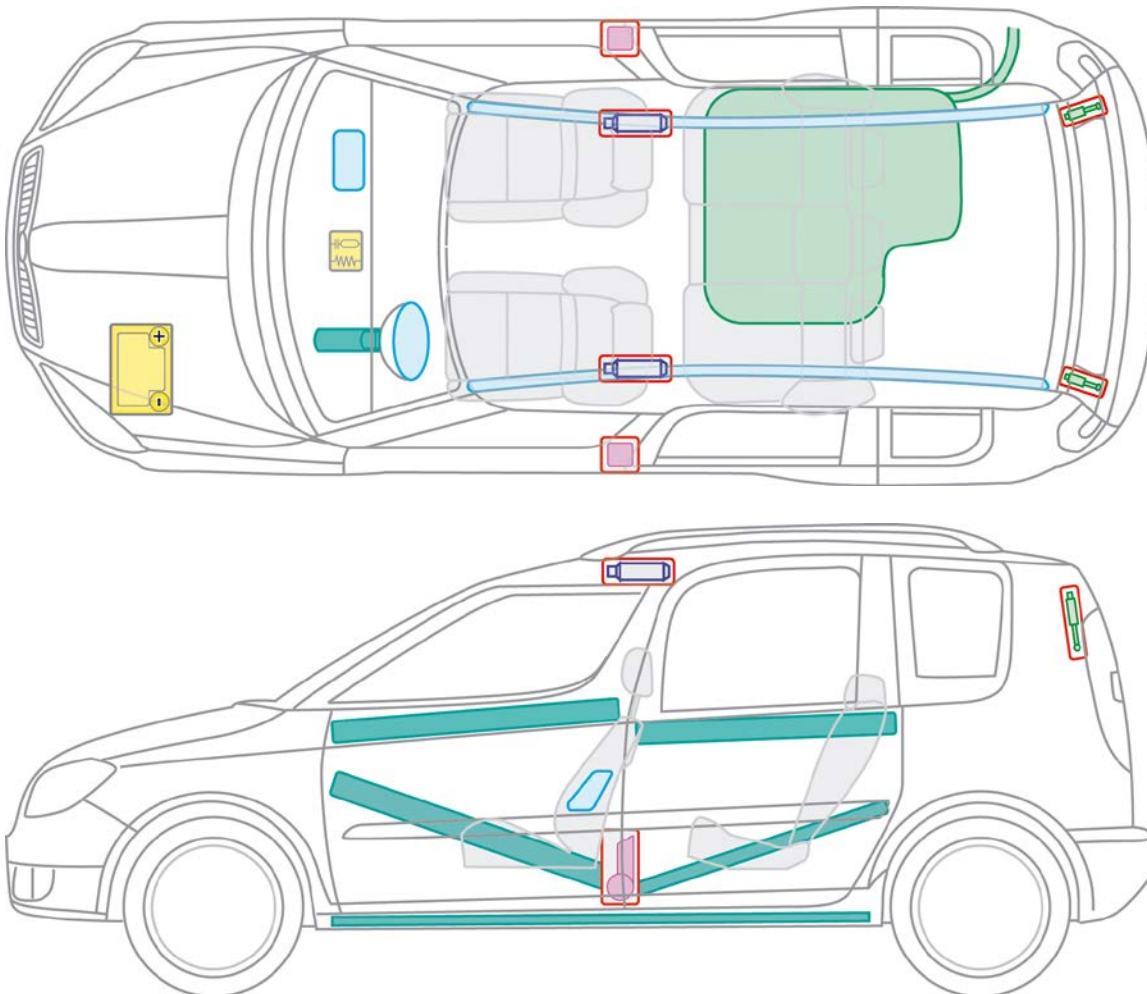

	Airbag		Karosserie- verstärkung		Steuergerät für Airbag
	Gas- generator		Batterie		Gurt- straffer
	Gasdruck- dämpfer		Kraftstoff- tank		



## Roomster ab 2006

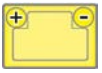

Legende

	Airbag		Karosserie- verstärkung		Steuergerät für Airbag
	Gas- generator		Batterie		Gurt- straffer
	Gasdruck- dämpfer		Kraftstoff- tank		







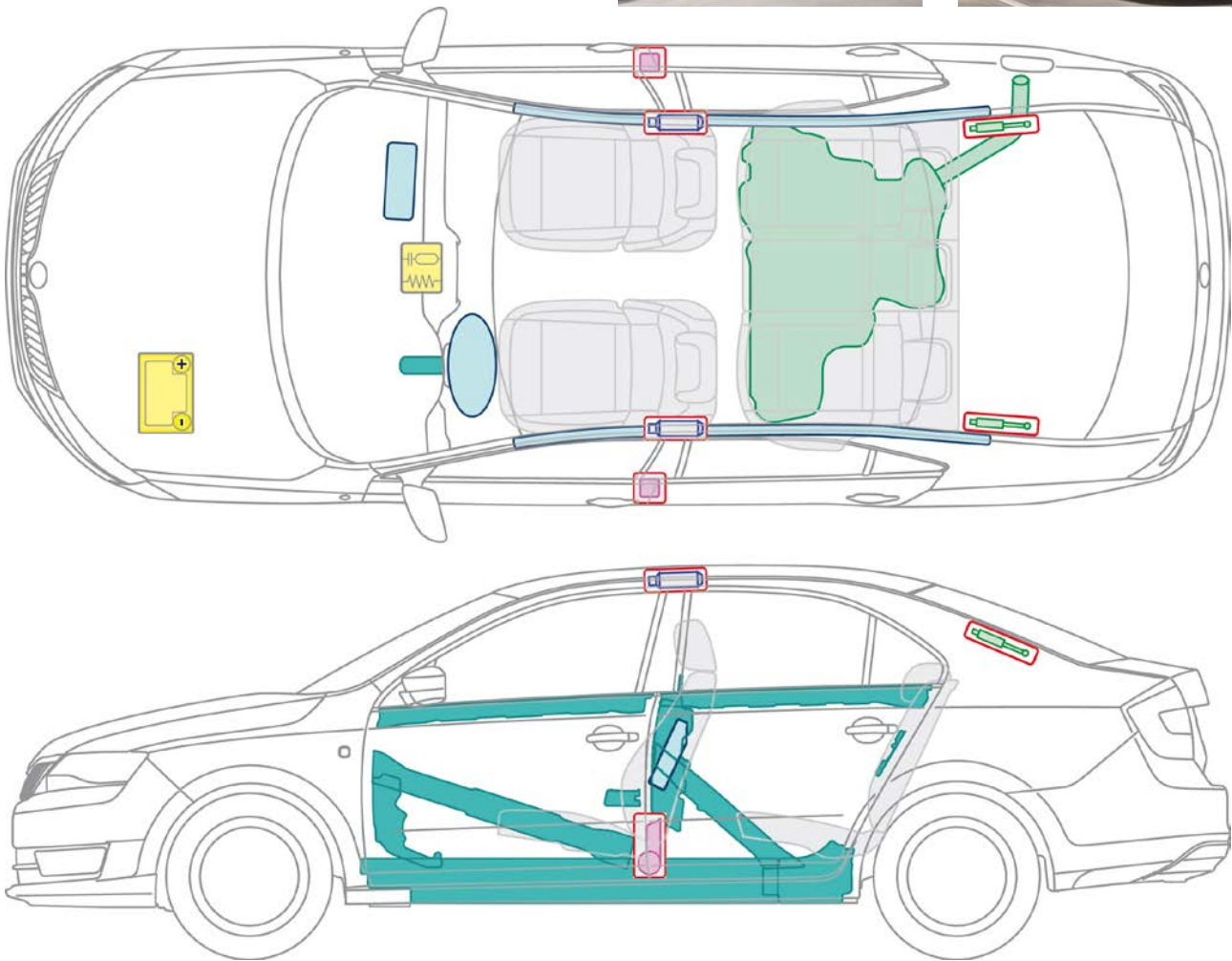



## Rapid NH ab 2012

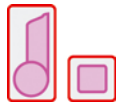

### Legende





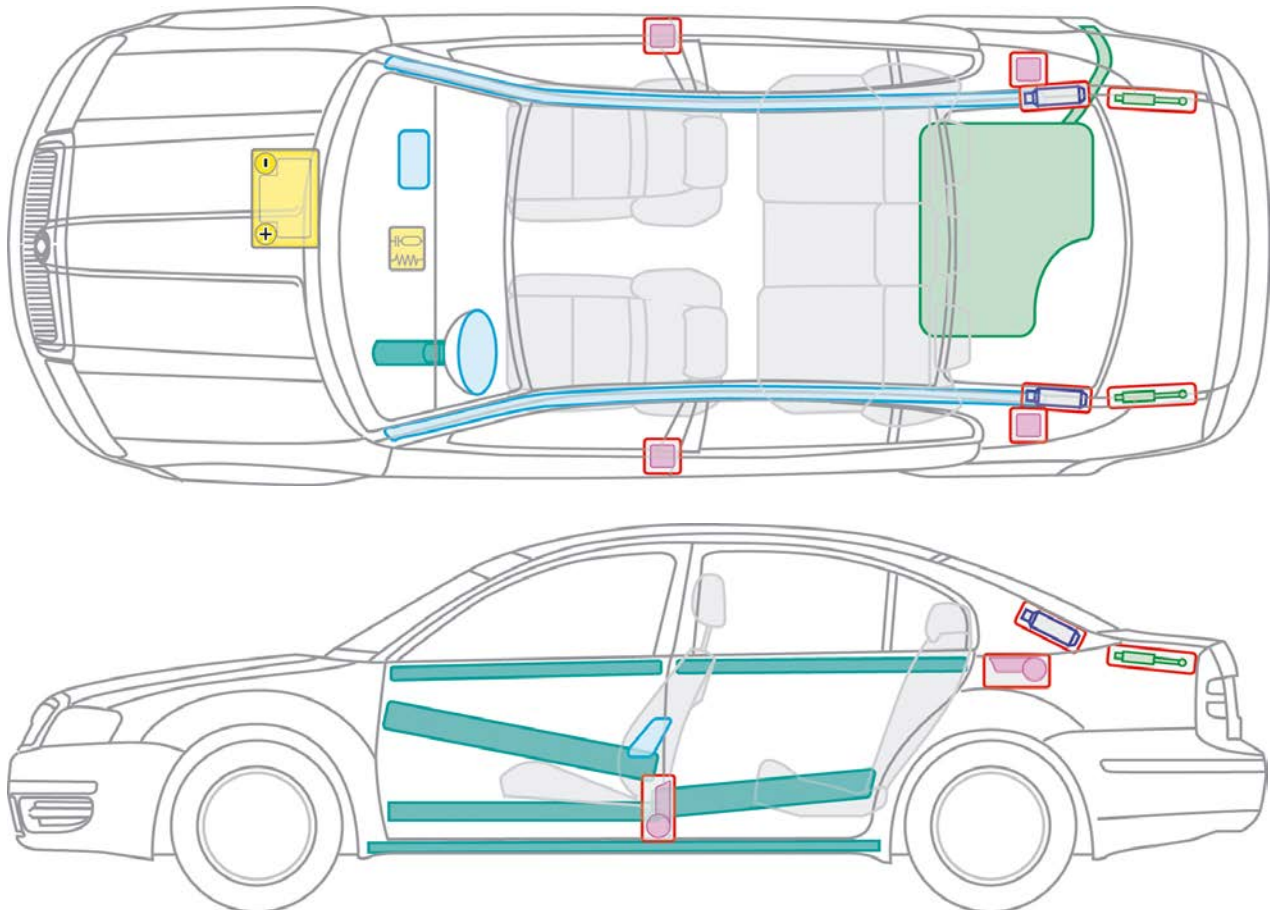

	Airbag		Karosserie- verstärkung		Steuergerät für Airbag
	Gas- generator		Batterie		Gurt- straffer
	Gasdruck- dämpfer		Kraftstoff- tank		



## Superb I 2001 - 2008

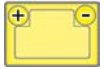

### Legende

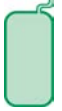
	Airbag		Karosserie- verstärkung		Steuergerät für Airbag
	Gas- generator		Batterie		Gurt- straffer
	Gasdruck- dämpfer		Kraftstoff- tank		





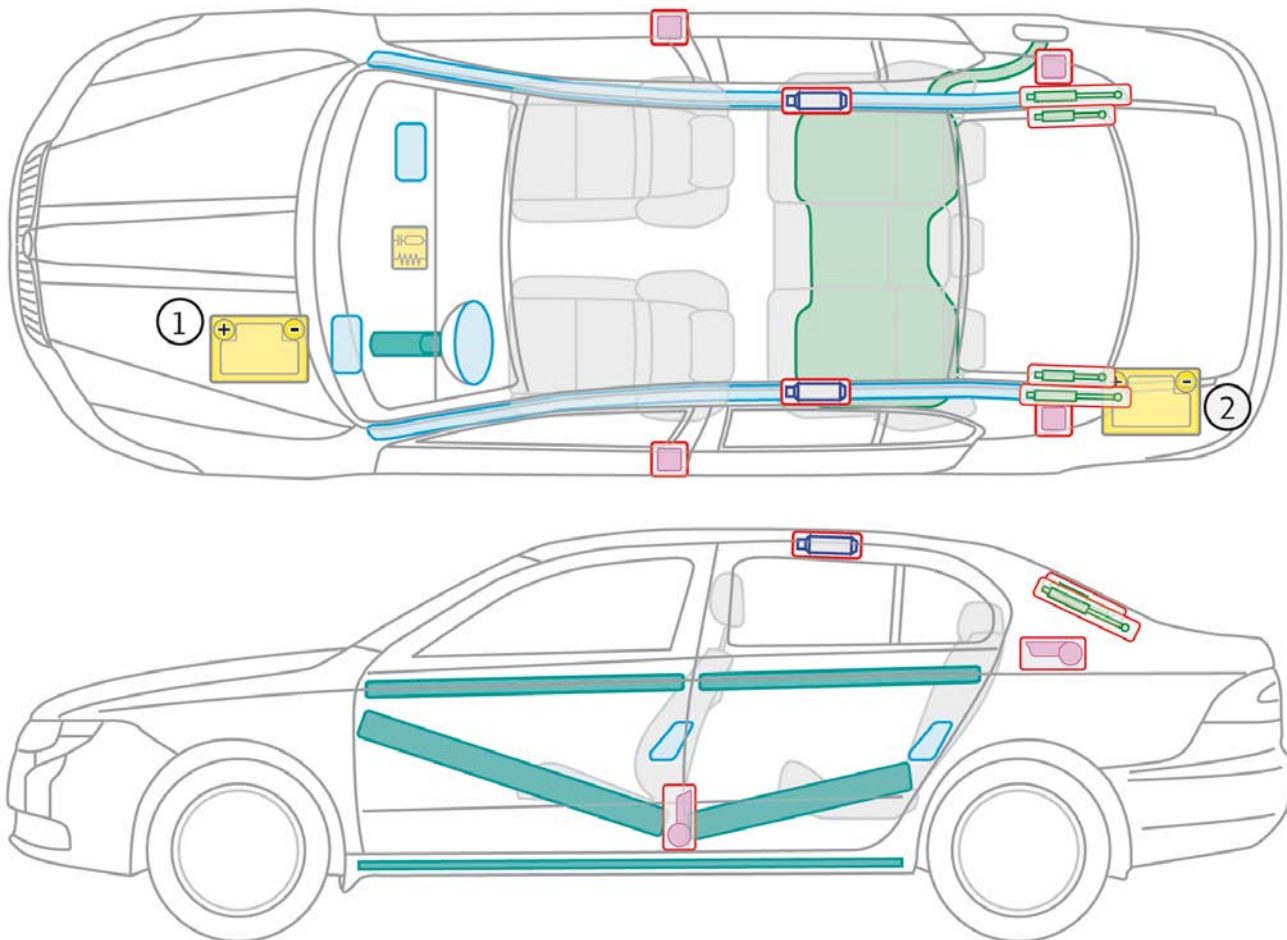



## Superb II ab 2008

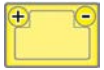
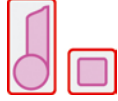

Legende

- ① alle Fahrzeuge, außer Motorisierung 3,6 I/191 kW  
 ② alle Fahrzeuge, mit Motorisierung 3,6 I/191 kW

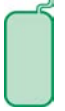
	Airbag		Karosserie- verstärkung		Steuergerät für Airbag
	Gas- generator		Batterie		Gurt- straffer
	Gasdruck- dämpfer		Kraftstoff- tank		





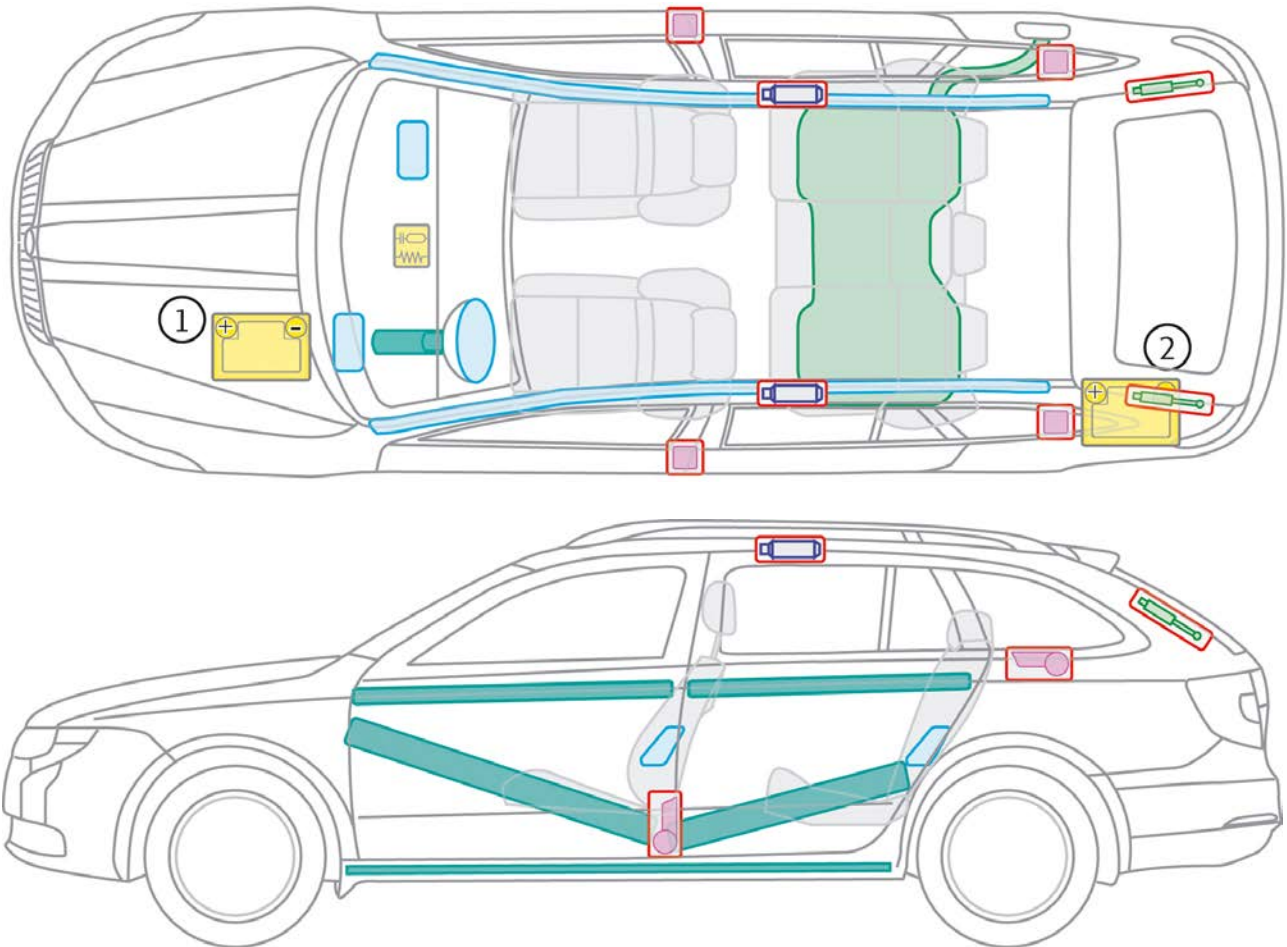



## Superb Combi II ab 2009

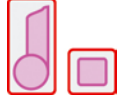

Legende

- ① alle Fahrzeuge, außer Motorisierung 3,6 I/191 kW  
 ② alle Fahrzeuge, mit Motorisierung 3,6 I/191 kW







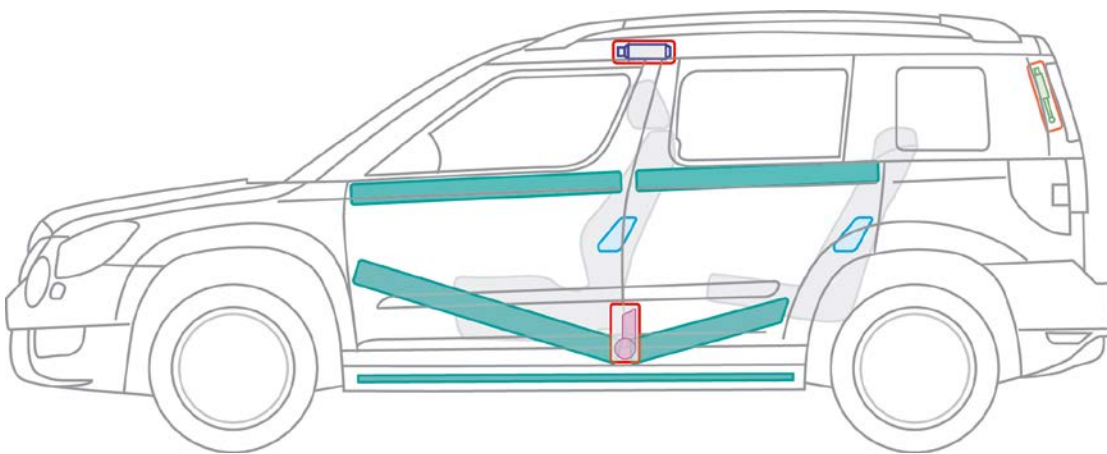
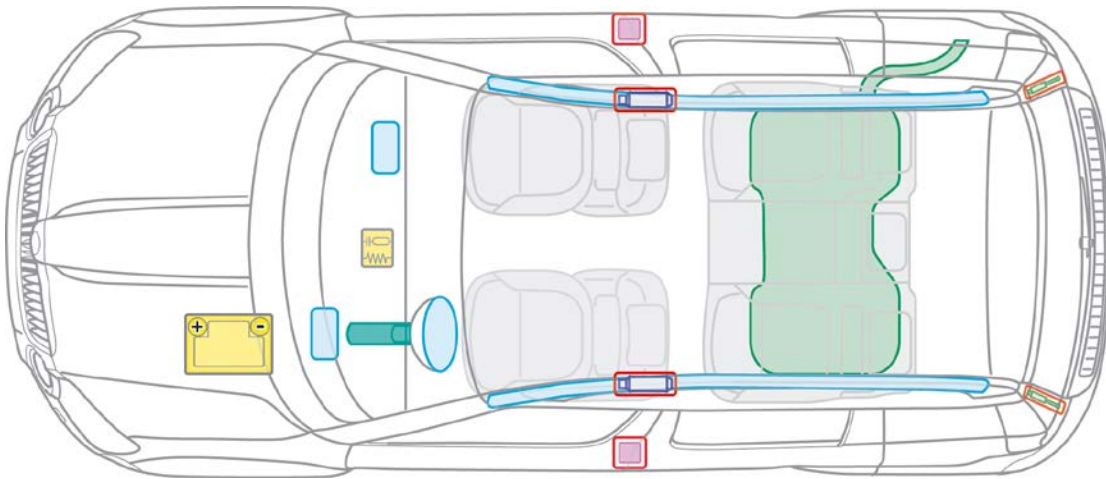

	Airbag		Karosserie- verstärkung		Steuergerät für Airbag
	Gas- generator		Batterie		Gurt- straffer
	Gasdruck- dämpfer		Kraftstoff- tank		



Yeti ab 2009

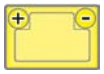

Legende

	Airbag		Karosserie- verstärkung		Steuergerät für Airbag
	Gas- generator		Batterie		Gurt- straffer
	Gasdruck- dämpfer		Kraftstoff- tank		